

99082

Dimensions

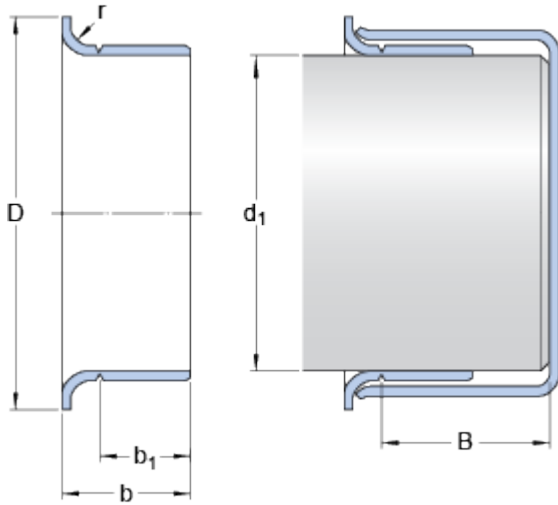

Nominal dimensions

d_1		18	mm
D		24.435	mm
Tolerance outside diameter D	\pm	1.6	mm
b		10.998	mm
Tolerance width b	\pm	0.8	mm
b_1		8.001	mm
Tolerance width b_1	\pm	0.8	mm
B	max.	45.999	mm
r	max.	3.18	mm

Shaft diameter range

d_1	min.	17.882	mm
d_1	max.	17.983	mm